

FCE60 Ignition Box

User Manual



FCE60 Ignition Box

User Manual



About FCE60 User Manual

Content and structure

This user manual for the FCE60 Ignition Box has been developed to provide the necessary information to install and operate the FCE60 Ignition Box. This English version of this manual constitutes the original version, and can therefore be used as a reference in case of doubt regarding use or misuse of the system.

The user manual is a practical guide for set-up, mounting, operating and maintaining the FCE60. The user manual has been divided into colour-coded sections, enabling the user to easily look up the potential subjects of the interest.

Safe use

Read the instructions before use. The FCE60 Ignition Box shall be installed in accordance with the rules in force. Particularly the section "Safety Instruction" p. [16] should be read thoroughly before use.

Getting thoroughly acquainted with the manual furthermore ensures the operator the full value of the system, as the user manual contains a multitude of practical dos and don'ts, as well as useful guidance on maintenance and troubleshooting. The user manual should always be stored together with the system.

To ensure safe use of the FCE60 Ignition Box, the operator is advised to perform an individual risk assessment of the use of the Ignition Box in combination with the relevant gas burner system.

The FCE60 is CE-marked and comply with regulations for security and reliability.

Copyright

This manual has been developed exclusively for users of the FCE60 Ignition Box to provide the necessary information to install and operate the FCE60 Ignition Box, and may only be used for this particular purpose. All information, text and pictures are the intellectual property of, and copyrighted material of TF-Technologies A/S. All rights are reserved. The manual may not be copied, displayed, quoted, published, sold, modified, or distributed without the written consent of TF-Technologies A/S.

Disclaimer

TF-Technologies A/S and its distributors may not be held liable for potential editorial errors, omissions or failure effects. Suggestions regarding updates or correction of potential errors are appreciated.

Contact information

TF-Technologies A/S
Kratbjerg 214
3480 Fredensborg
Denmark
T: +45 4848 2633
E: sales@tf-technologies.com

User manual information

Document name: FCE60 User Manual
Document number: G704002
Publication date: 14. March 2016

FCE60 Ignition Box

The FCE60 Ignition Box contains a model number/name, serial number and a part number, so that each unit is easily identified and traceable. All relevant numbers should be stated, when contacting TF-Technologies regarding your product:

Example	
Model number/name:	FCE60
Serial number:	TF-66123
Part number:	S-51590

Symbol overview

This user manual uses a range of symbols and warning notifications throughout the manual to make the operator aware of important safety measures or information regarding installation or operation. The following symbols are used in this manual:



Warning!

Indicates important information the operator must be aware of to avoid dangerous situations that can result in death or serious personal injury



Caution!

Indicates important information the operator must be aware of to avoid dangerous situations which can result in material damages



Tip

Indicates information regarding efficient and failure-free operation of the Mini-Line® Grade and Slope Control System



Step-by-step instructions

Indicates a step-by-step instruction, where a particular order of actions is required

Table of Contents

About the FCE60 Ignition Box User Manual	4
--	---

Introduction

About the FCE60 Ignition Box.....	9
Why use the FCE60 for your gas burner system.....	10
How the FCE60 Ignition Box works	11
Why the FCE60 is better than other ignition controllers	12
Where can the FCE60 Ignition Box be used	16
Backwards compatibility.....	17

Operation

Operating the FCE60 Ignition Box.....	19
Operating the FCE60 Ignition Box.....	20

Configuration

System Configurations	22
Ignition Control System without Temperature Controller (stand-alone)	23
Temperature Control System with Temperature Controller	29

Installation

Essential components for installation	41
Installing the FCE60 Ignition Box.....	45

Safety Instructions

Requirement for the gas burner system	52
Correct use.....	54
Incorrect use	56
Warnings and Dangerous Situations.....	57

Maintenance	
Service and Repair	59
Transport.....	59
Storage	60
Cleaning	60
Disposal	60
Appendix	
Trouble-shooting	63
Local Assembly of High Tension Cord	64
Technical Specifications (data sheets)	66
Certificate.....	72
Declaration of Conformity	73



Introduction

About the FCE60 Ignition Box.....	9
Why use the FCE60 for your gas burner system.....	10
How the FCE60 Ignition Box works.....	11
Why the FCE60 is better than other ignition controllers	12
Where can the FCE60 Ignition Box be used.....	16
Backwards compatibility.....	17

About the FCE60 Ignition Box

The FCE60 Ignition Box is an ignition controller designed for use in gas burner systems for controlling the gas flow and gas ignition. When used correctly, it prevents gas accidents and secures a smooth operation of the gas system.

The FCE60 Ignition Box is certified to the standard EN 298:2012 *Automatic burner control systems for burners and appliances burning gaseous or liquid fuels*.

This certification ensures that the FCE60 has been developed to the highest safety standards for electrical design of control devices for gas systems, and comply with the European gas safety requirements.

The FCE60 is a simple plug'n'play ignition controller operating automatically when supplied.

The development of the FCE60 Ignition Box builds on more than 30 years of experience with the development of ignition

controllers for gas systems in highly durable applications, such as in road machines.

The FCE60 is fit for integration in gas systems on machinery as well as consumer appliances, but is particularly suitable for machine integration, as it is highly resistant to electronic disturbance from surrounding electronic products and tested to EN13309:2010 *Construction Machinery - Electromagnetic Compatibility of Machines with Internal Power Supply*.

The FCE60 Ignition Box can be used as a stand-alone ignition controller in systems designed for continuous burning for up to 24 hours, or with a temperature controller that maintains a specific temperature level.

It is applicable in single-burner systems as well as multi-burner systems, and can be connected to both 12V and 24V DC power supply.

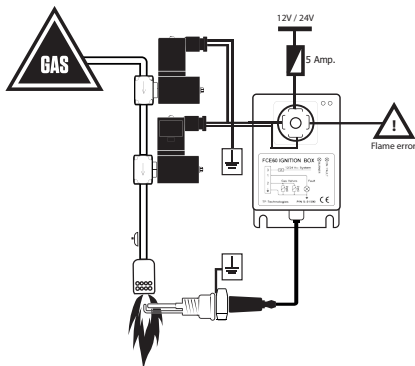

Fig. 1 - FCE60 Ignition Box in stand-alone configuration with one gas burner

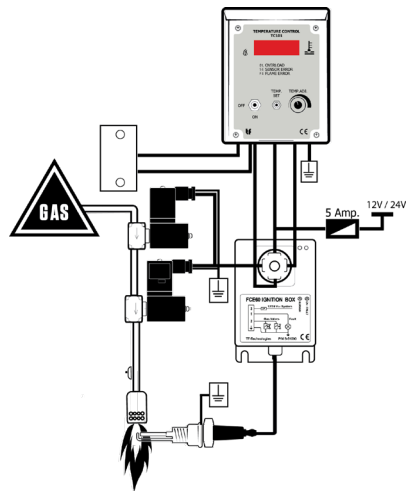

Fig. 2 - FCE60 Ignition Box in configuration with temperature controller and one gas burner

Why use the FCE60 for your gas burner system

A gas burner system consists of a gas supply, gas pipes, a gas solenoid valve, a gas burner and a gas ignition device. A simple example of a gas burner system is displayed below.

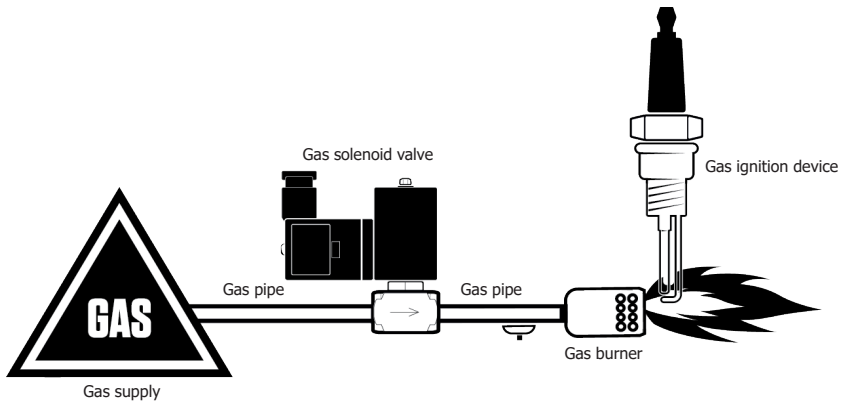

Fig. 3 - Gas burner system with gas supply, gas pipes, gas solenoid valve, gas burner and gas ignition device

Provided the burner is functional and gas pipes are tight, the basic functionality of the gas system is to open and close the gas valve and ignite the gas. The key to a smooth and safe operation of the gas system is to make sure the gas is ignited when supplied and remains lit throughout operation, so that no gas seepage takes place.

Because the use of gas as a heating solution is combined with the danger of explosions due to excessive seepage of gas, igniting the gas and making sure that it remains lit is not something to be done safely by a person.

Instead, an ignition controller such as the FCE60 Ignition Box ensures just that.

How the FCE60 Ignition Box works

The FCE60 Ignition Box controls the gas supply by opening and closing an electronic gas solenoid valve, and uses a spark plug to instantly ignite the gas, when supplied. It continues to monitor the flame throughout operation, and any accidental blow-out of the flame immediately triggers automatic re-ignition. In case of re-ignition failure, the FCE60 will close the gas valve as a safety measure to prevent accidents caused by gas seepage.

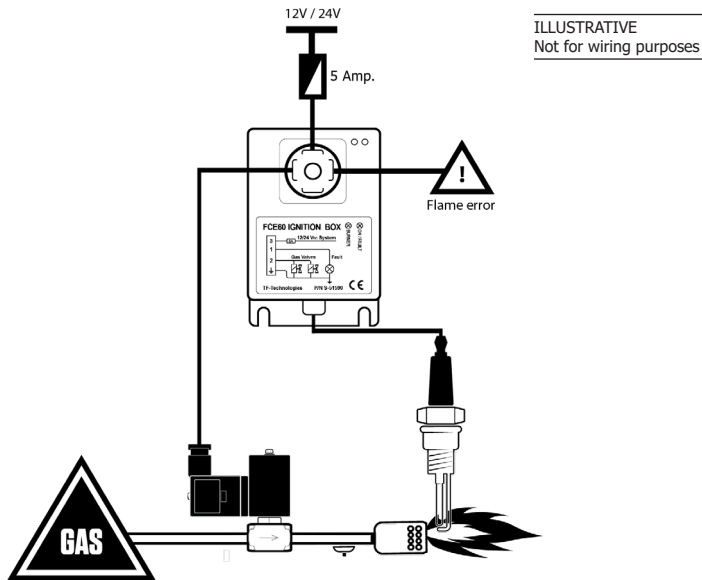

Fig. 4 - Gas burner system with FCE60 Ignition Box

The FCE60 ignites the gas with an electronic discharge in a spark plug connected with a high tension cable. The electronic ignition makes it far easier and safer to ignite the gas, compared to a person manually igniting the gas, and at the same time the electrode is used for automatic flame control.

Monitoring the flame is a major advantage, as it greatly minimizes the risk of gas explosions due to flame failure. To monitor the flame, the FCE60 uses the concept of ionization. The combustion of the gas creates chemical reactions and an elevated temperature that creates local ionization in the flame. By applying voltage to the spark plug between the sparks, the ionized gas forms a current known as ionization current that the FCE60 Ignition Box is able to measure. It is by measuring this ionization current that the FCE60 is able to know whether a flame is present.

Why the FCE60 is better than other ignition controllers

The FCE60 Ignition Box has been developed adhering to the highest safety standards for electrical design. When using the FCE60 as prescribed in this manual, the manufacturer can rest assured that his gas burner system in his machine or consumer appliance meets the highest standards for gas safety.

Specifically designed to comply with strict safety regulations for design of gas systems

The FCE60 Ignition Box was built specifically to comply with international strict regulations for the design of safe gas burner systems. In the European Union, the gas safety requirements are specified in the 2009/142/EC Gas Appliances Directive and 2006/42/EC Machinery Directive for consumer appliances and machinery respectively.

The FCE60 is EN 298 certified with full compliance to

- 2009/142/EC Gas Appliances Directive
- 2006/42/EC Machinery Directive

Because ignition controllers like the FCE60 control the gas flow and monitor the ignition, they are characterized in these Directives as safety devices, which entails that when used in a gas system on a machine or in a consumer appliance, they must be designed, so that a potential failure of the device does not result in an unsafe situation.

This sets very high demands on the electrical design as specified in the harmonized standard EN 298, and also entails that a certification that all these demands have been met is mandatory.

The FCE60 Ignition Box is fully certified to the standard EN 298:2012 *Automatic Burner Control Systems for Burners and Appliances Burning Gaseous Fuels*. This is your guarantee for a failure-safe ignition controller in full compliance with the European legislation. Please refer to the certificate in the Appendix of this manual.

In the US, Canada and Australia the legislation is very similar, and the EN 298 certification will typically correspond to the gas safety requirements in these regions.

EN 298 certified - your guarantee for a failure-safe ignition controller

The EN 298 certification of the FCE60 entails high demands to the functionality and the electrical design, as it is required to maintain a safe electrical control of a gas burner system, even in the face of several internal failures.

The FCE60 therefore has several built-in redundancies, including double relay, an internal fuse and three control circuits that individually control the flame detection performed by the FCE60.

This means the FCE60 Ignition Box will maintain a safe gas system even in cases of overcurrent, a permanent short circuit of the gas solenoid valves, or up to two individual component failures, all of which could otherwise result in a dangerous gas leakage.



The design of the FCE60 Ignition Box certified to the EN 298 standard is therefore your guarantee for a failure-safe ignition controller that maintains gas safety even under adverse conditions.

The FCE60 maintains gas safety even in cases of

- Overcurrent
- Short circuit of gas solenoid valves
- Up to two component failures

Certain other demands for configuration and installation are required under the 2009/142/EC Gas Appliances Directive and 2006/42/EC Machinery Directive, please refer to the relevant sections of this manual.

Non-certified ignition controllers offer false sense of safety

There are still many outdated non-certified ignition controllers available in the market that do not comply with the current gas safety requirements, offering a false sense of safety for the user, as well as the manufacturer of the machine or consumer appliance with the gas system in which the ignition controller has been incorporated.

Such non-certified ignition controllers are outdated and not suitable for their application, as they will not have the required built-in redundancy. Their simple electrical design is not suitable for a safety device such as an ignition controller and do not provide for a safe gas system.

For example, a single component failure due to overheating or product ageing could lead to false flame detection or inability to control the gas solenoid valve output, which can result in a dangerous gas leakage. Likewise, a short circuit of the gas solenoid valve could leave the ignition controller unable to shut off any gas solenoid valves, also resulting in a highly unsafe gas system.

A non-certified ignition controller can result in serious personal injury and makes the manufacturer open to product liability claims

So not only do these non-certified, outdated ignition controllers not comply with the current gas legislation in most parts of the world – in the EU making it illegal to CE mark the machine or appliance they are incorporated in – these outdated models also put the manufacturer of the machine or appliance with the gas system in question at great risk of product liability claims in case of accidents.

The manufacturer of the gas system is in a very bad position in the face of such allegations of unsafe equipment, as the lack of EN 298 certification of the ignition controller makes it very easy to prove that the proper gas legislation has been ignored.

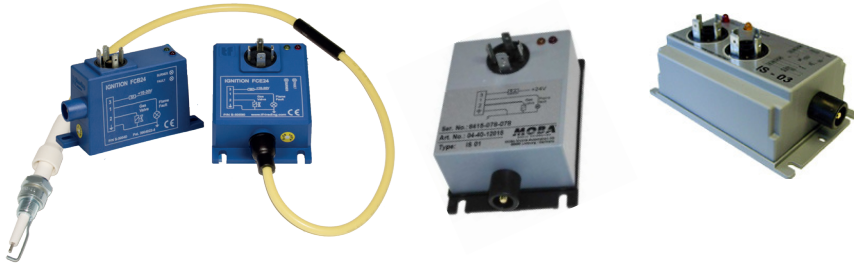

Fig. 5 - Examples of non-certified outdated ignition controllers not suitable for the EU, US and Australian markets

Years of experience providing reliable and durable design

The development of the FCE60 Ignition Box builds on more than 30 years of experience with the development of ignition controllers for gas systems in highly durable applications, such as in road machines. This tried and true technology has now been applied in a new version developed to comply with the high safety requirements of today's strict gas regulations.

The electronics is fully encapsulated in a flame retardant housing, making the FCE60 particularly robust even in rough environmental conditions. The hardy cable connecting the spark plug to the FCE60 can endure many years of continuous use. This ensures an extremely robust controller and more 50,000 units of the FCE60 and its predecessors have already operated successfully in the field in a vast array of tough applications.

Resistant to electronic disturbance

The electronic signals of the FCE60 Ignition Box are highly resistant to electronic disturbance from surrounding electronic products, and the FCE60 is tested to the standard EN 13309:2010 *Construction Machinery - Electromagnetic Compatibility of Machines with Internal Power Supply* for full compliance to the 2014/30/EU Electromagnetic Compatibility Directive.

Simple plug'n'play solution with compact design

The FCE60 Ignition Box is very compact in size allowing for installations even where space is limited, as is often the case on machinery or in appliances, and particularly relevant in configurations with multiple burners.

It is easy to install with no settings or required software setup.

Flexible solution that can be used in many different gas systems

Gas burner systems in various applications and machines by different manufacturers come in many forms and shapes, which entails that the design of the ignition control section differs greatly. The FCE60 Ignition Box is a flexible solution that can be used in a wide array of these systems, as it can be incorporated in a broad range of configurations.

It is applicable in single-burner systems as well as multi-burner systems, and can be connected to both 12V and 24V DC power supply.

It can be used both as a stand-alone ignition controller in systems designed for con-

tinuous burning for up to 24 hours or with a temperature control module that maintains a specific temperature level.

Other Advantages of FCE60

- Reliable and durable design
- Resistant to electronic disturbance
- Tested to EN 13309:2010
- Compact, simple plug'n'play solution
- No settings or software setup
- For single- or multiburner system
- Connects to 12V and 24V DC
- For use with or without thermostat

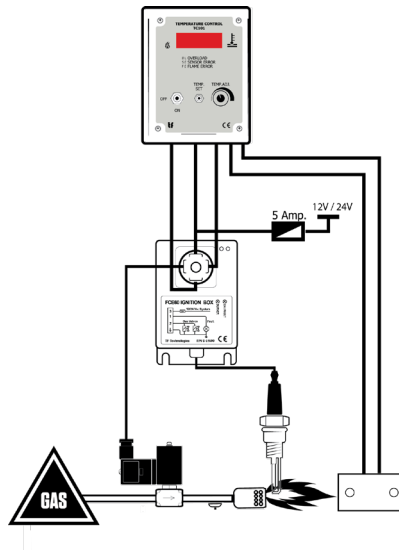

ILLUSTRATIVE
Not for wiring purposes

Fig. 6 - Gas burner system with FCE60 Ignition Box and Temperature Controller

Where can the FCE60 Ignition Box be used

The FCE60 Ignition Box can be used for controlling the gas flow and gas ignition in any gas burner system with a maximum burner output of 360kW per burner, where the FCE60 can be connected to a 12V or 24V DC system, and has a valve output of maximum of 2.5A.

The FCE60 Ignition Box can be utilized in systems designed for permanent operation, but the Ignition Box should be shut off and restarted once every 24 hours as a safety measure, to allow the FCE60 to perform a start-up check and to ensure all functions are working.

The gas burner system and any individual components herein, including gas valves, fittings, hoses, and regulators must be constructed in accordance with general statutory gas safety regulations.

When the FCE60 Ignition Box is installed in a gas system on a machine, there are certain other requirements for the safe operation, please refer to Safety Instruction p. 45 and Configuration p. 18.

What is the EN 298 standard and why is it important?

The 2009/142/EC Gas Appliances Directive (GAD) specifies mandatory gas safety regulation for gas burner systems in appliances marketed in the EU, whereas the 2006/42/EC Machinery Directive (MD) specifies mandatory gas safety regulation for gas burner systems in machinery.

Manufacturers as well as distributors are directly liable in cases of gas safety issues or accidents, where these Directives have not been complied with. Compliance is therefore essential from both a moral and a legal perspective.

Both GAD and MD refer directly to the harmonized standard EN 298 for compliance for automatic burner control systems, and additionally MD (in Article III) refer

more indirectly to GAD. In effect, this entails that any gas burner system marketed in the EU is required under EU law to comply with GAD, and where the gas burner system includes an automatic control system, such as an ignition box, it shall comply specifically with the EN 298 standard.

Where compliance to harmonized standards is normally voluntary, the serious nature of gas-related accidents entails that GAD has a mandatory requirement for a notified body certification to document compliance to the EN 298 standard.

This means that using a non-EN 298-certified ignition box in a gas burner system in an appliance or a machine makes it illegal to mark the appliance or machinery with the CE mark and sell it on the EU market.

Backwards compatibility

The FCE60 Ignition Box is backwards compatible with the former non-certified FCE24 Ignition Box. The FCB24 Ignition Box only differing from the FCE24 in its physical dimensions, will not become available in a new EN 298 certified version, as the housing does not leave room for a circuit board that can contain the required components to satisfy the safety requirements.

Similarities and differences of the FCE60 and FCE24 Ignition Boxes

**FCE24 Ignition Box
(old version)**



**FCE60 Ignition Box
(new version)**



Commonalities

- Identical housing
- Activation (GND)
- Yellow flame diode
- Max. 2.5A (gas)
- Min. 10 Hz spark frequency
- Length of high tension cords 0.4 - 5.85m
- CE marked (EMC directive)

Functions

- Red error diode
- Direct spark (constant)

- Red/green status diode
- 1 sec. start-up check
- 3 gas control circuits

Specifications

- 10-30 VDC
- -10 - +85°C
- App. 7 sec. safety time

- 12/24 VDC system
- -10 - +70°C
- <10 sec. safety time

Design

- 1 relay
- 2-layer circuitboard
- 90 components
- 4 transistors

- 2 relays + internal fuse
- 4-layer HDI circuitboard
- 400+ components
- 100 transistors



Operation

Operating the FCE60 Ignition Box.....	19
Operating the FCE60 Ignition Box.....	20



Operating the FCE60 Ignition Box

Safe use

Before the FCE60 Ignition Box is installed and operated, it is important that the installer and operator have been informed and understand the section Safety Instruction, p. 45.

General operation

The FCE60 Ignition Box automatically starts operation when power is applied.

The operation begins with a brief one second safety check, where functionality and gas solenoid valve power is tested. Once confirmed, the FCE60 Ignition Box opens the gas supply and starts the ignition.

When the FCE60 detects a flame, the Ignition Box will cease sparking. After this, the FCE60 will continue to monitor the flame. If no flame is detected or in case the flame disappears later, the FCE60 Ignition Box will initiate sparking to attempt re-ignition. If a flame is still not detected within a safety time of max 10 seconds, the FCE60 stops sparking, and turns off the gas supply by closing the gas solenoid valves. When the Ignition Box closes the gas solenoid valves, a red lamp will indicate a fault mode.

The gas solenoid valves will remain closed until a power-down and power-up is performed for the FCE60 Ignition Box.

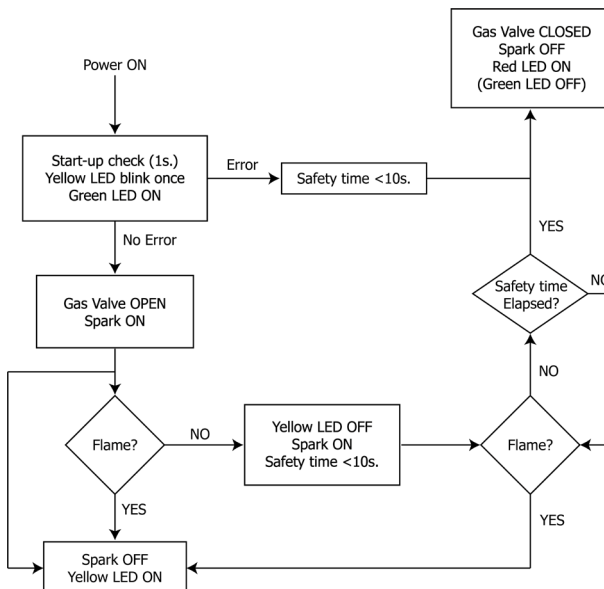
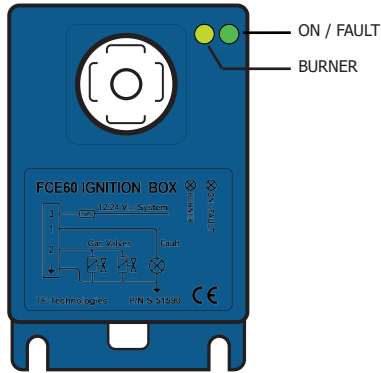

Fig. 6 - General operation of the FCE60 Ignition Box

Operating the FCE60 Ignition Box

Light indicators

The FCE60 Ignition Box features two LEDs that display the status of operation. One LED indicates the burner mode and one LED indicates whether the unit is on or in fault mode.



Display	Operation mode	Description	Gas Valve
	Power OFF	FCE60 Ignition Box has no power supply	Closed
	Start-up check	FCE60 Ignition Box is supplied, and checks gas valve power and no flame presence	Closed
	Igniting	FCE60 Ignition Box is trying to ignite the supplied gas, either following start-up mode or flame loss	Open
	Running	FCE60 Ignition Box monitors flame presence	Open
	Flame failure	FCE60 Ignition Box did not succeed igniting the gas and is in flame failure mode	Closed



Configuration

System Configurations	22
Ignition Control System without Temperature Controller (stand-alone)	23
Temperature Control System with Temperature Controller	29

System Configurations

The FCE60 Ignition Box can be used in two overall system configurations: An ignition control system, where the FCE60 Ignition Box operates on a stand-alone basis and a temperature control system configuration, where the FCE60 Ignition Box is integrated in a temperature control system with a temperature controller.

multi-burner setup, but the setup varies with the overall configuration.

The two overall system configurations are therefore described separately, but the requirements that apply to both types of overall system configurations, irrespective of the number of burners, are outlined below.

Both of these overall configurations can be applied for a single-burner setup and a



The gas solenoid valves must be EN 161 approved to comply with the gas regulations of the 2009/142/EC Gas Appliances Directive and the 2006/42/EC Machinery Directive



The high tension cord connecting the spark plug to the FCE60 Ignition Box must feature a noise resistor



The FCE60 Ignition Box, temperature controller, temperature sensor, high tension cords and all other system accessories must only be installed in configurations where they operate within their specifications



Ignition Control System without Temperature Controller (stand-alone)

In the Ignition Control System configuration, the FCE60 is used as a stand-alone ignition controller in a gas system designed for continuous burning. In this system, the FCE60 Ignition Box will maintain the gas lit throughout operation, from system power-up to system power-down.

The operator must ensure that the Ignition Control System does not run for more than 24 consecutive hours, as the FCE60 is not designed for continuous operation beyond 24 hours.

An Ignition Control System with the FCE60 Ignition Box can be set up with one or multiple burners.



The maximum continuous operation time for the FCE60 Ignition Box is 24 hours



Pin 1 (orange wire) on the FCE60 Ignition Box can be connected to a lamp to indicate flame failure

Ignition Control System (stand-alone) with a single burner

The most basic configuration with the FCE60 Ignition Box is the Ignition Control System configuration with one single burner. This configuration is displayed in figure 7.

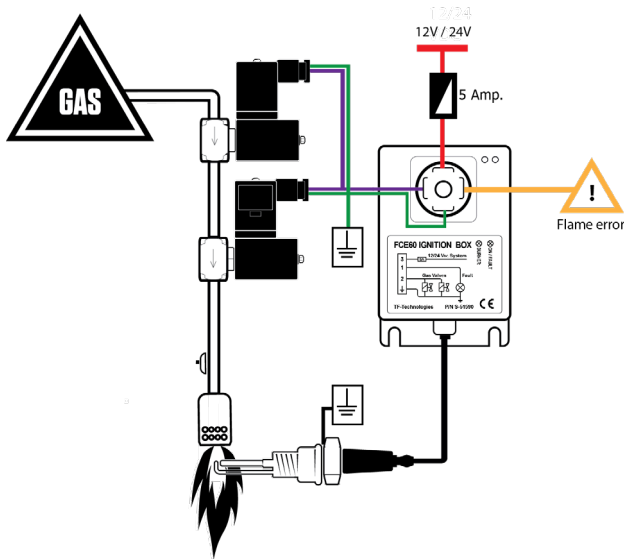

Fig. 7 - FCE60 Ignition Box in stand-alone Ignition Control System configuration with one single burner



The Ignition Control System must be designed with two gas solenoid valves connected serially to the gas supply to comply with the gas regulations of the 2009/142/EC Gas Appliances Directive and the 2006/42/EC Machinery Directive



A fuse of minimum 5A for overcurrent protection must be installed between the power supply and the FCE60 Ignition Box



Ignition Control System (stand-alone) with up to four burners

The Ignition Control system with the FCE60 Ignition Box in a configuration with multiple burners up to a total of four burners is displayed in figure 8. One FCE60 Ignition Box per burner is required and they must be serially supplied to ensure the safety of the gas system in case any one of the FCE60 detects a flame error. Serially supplied entails that the first FCE60 Ignition Box is connected to the power supply, the next FCE60 is supplied via the gas valve output of the first FCE60 and so on. The last FCE60 in the series supplies the two gas valves that are connected to this FCE60 in parallel.

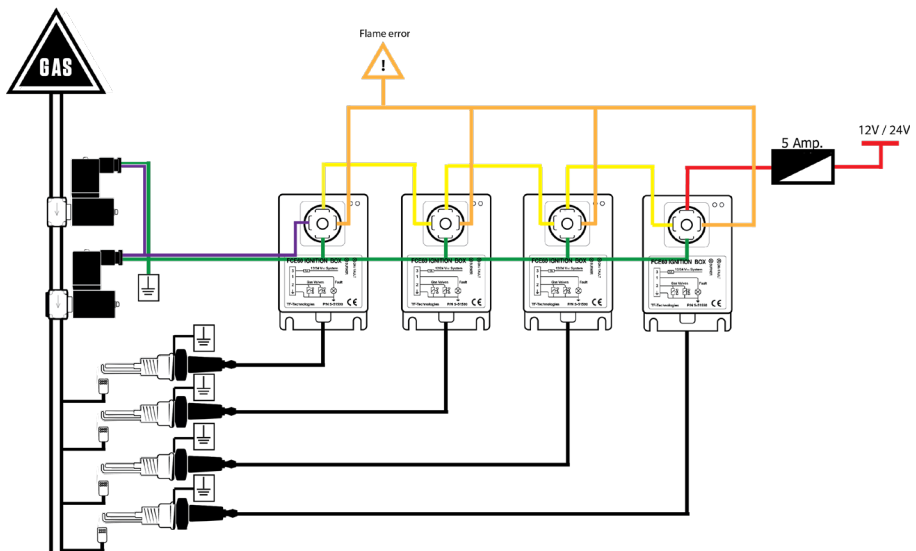

Fig. 8 - FCE60 Ignition Box in stand-alone Ignition Control System configuration with up to four burners

Because the FCE60 Ignition Box performs a one second safety check upon start-up, when connected serially, there will be a delay of one second per FCE60 connected in the series, before the last FCE60 is powered up and the gas solenoid valves are opened. After the last FCE60 has opened the gas solenoid valves, we need to allow sufficient time for the first FCE60 to ignite the gas and detect the flame, before its safety time, i.e. the amount of time the FCE60 will check for flame presence before it closes the gas solenoid valves, has timed out and the first FCE60 closes the gas solenoid valves.

Since the safety time is < 10 seconds, and each FCE60 in the series adds a delay of 1 second, in order to allow sufficient time for the first FCE60 to ignite the gas and detect the flame, no more than four FCE60 Ignition Boxes should be connected serially.



The Ignition Control System should be configured so that no more than four FCE60 Ignition Boxes are connected serially to the gas solenoid valves

The amount of time required for the FCE60 Ignition Box to detect the flame depends heavily on the burner in question and the quality of the flame produced, as well as the exact positioning of the spark plug correctly in the middle of the flame. In some cases, it may be possible to connect more than four FCE60 serially to the gas valves and maintain system functionality, in other cases it may be less than four FCE60 Ignition Boxes. If you have problems maintaining functionality with less than four serially connected FCE60, we first recommend trying to optimize the spark plug position, please refer to p. 41. If it is still not possible to obtain a functional system, the system must be reconfigured as an Ignition Control System with more than four burners, but with fewer FCE60 in each series.

Just as in the single-burner configuration, two gas valves must be connected serially to the gas supply for a sufficiently safe gas system.



The Ignition Control System must be designed with two gas solenoid valves connected serially to the gas supply to comply with the gas regulations of the 2009/142/EC Gas Appliances Directive and the 2006/42/EC Machinery Directive



A fuse of minimum 5A for overcurrent protection must be installed between the power supply and the FCE60 Ignition Boxes

If an indication of flame error is required, pin 1 (orange wire) on all the FCE60 Ignition Boxes must be connected to a flame failure indicator in parallel.

Ignition Control System (stand-alone) with more than four burners

Because the maximum number of FCE60 Ignition Boxes that can be connected serially to the gas solenoid valves is four, a system configuration with more than four burners, requires one more series of FCE60 Ignition Boxes. Each series must still be connected to two gas solenoid valves, and all gas solenoid valves must be serially connected to the gas supply before all burners to ensure the safety of the gas system in case any one of the FCE60 detects a flame error.

Figure 9 displays an Ignition Control System with the FCE60 Ignition Boxes in a configuration with up to eight burners.

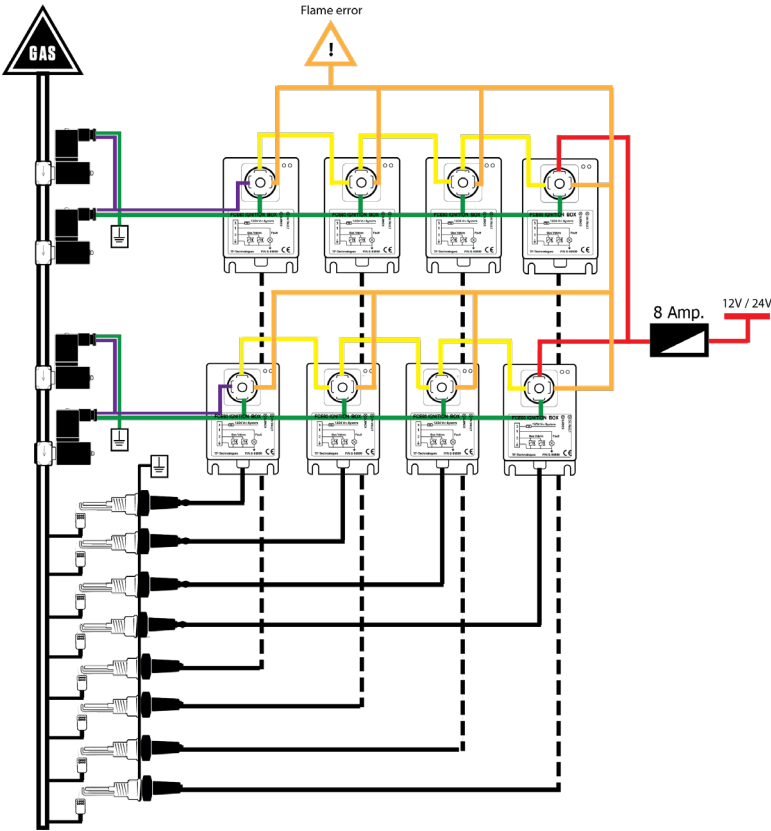

Fig. 9 - FCE60 Ignition Box in stand-alone Ignition Control System configuration with more than four burners

Configuration



To comply with the gas regulations of the 2009/142/EC Gas Appliances Directive and the 2006/42/EC Machinery Directive, the Ignition Control System with more than four burners must be designed, so that each series of up to four FCE60 connect to two gas solenoid valves connected serially to the gas supply



A fuse of minimum 8A for overcurrent protection must be installed between the power supply and the ignition control system configuration

As long as the system is configured with a maximum of four FCE60 Ignition Boxes in each series, it is possible to expand the system indefinitely with more series of Ignition Boxes. The number of series possible is limited only by the battery capacity, but the fuse for overcurrent protection should be adjusted accordingly.

If an indication of flame error is required, pin 1 (orange wire) on all the FCE60 Ignition Boxes must be connected to a flame failure indicator in parallel.



Temperature Control System with Temperature Controller

In the Temperature Control System configuration, the FCE60 Ignition Box is integrated in a temperature control system with a temperature controller.

This type of gas system is designed to maintain a specific material temperature, and a temperature sensor will be connected to the temperature controller that compares the temperature measurements to a user specified temperature setting. The FCE60 Ignition Box will be controlled by the temperature controller that will turn the FCE60 on and off to maintain the specified temperature.

A Temperature Control System with the FCE60 Ignition Box can be set up for one or multiple burners.

TF-Technologies can deliver a complete Temperature Control System to one or more gas burners. The system is fully integrated in a closed cabinet with all connections assembled in a central terminal and designed specifically to the specifications of the individual manufacturer, while ensuring full compliance to the European gas safety regulations. This is the easiest solution to ensure a safe and correctly configured system, and offers the benefit of a practical plug'n'play solution, ready for quick installation on the relevant machinery or appliance.

Due to the complex nature of the European safety regulations, it is not recommended for manufacturers without extensive knowledge of this area to perform the configuration of these systems themselves.

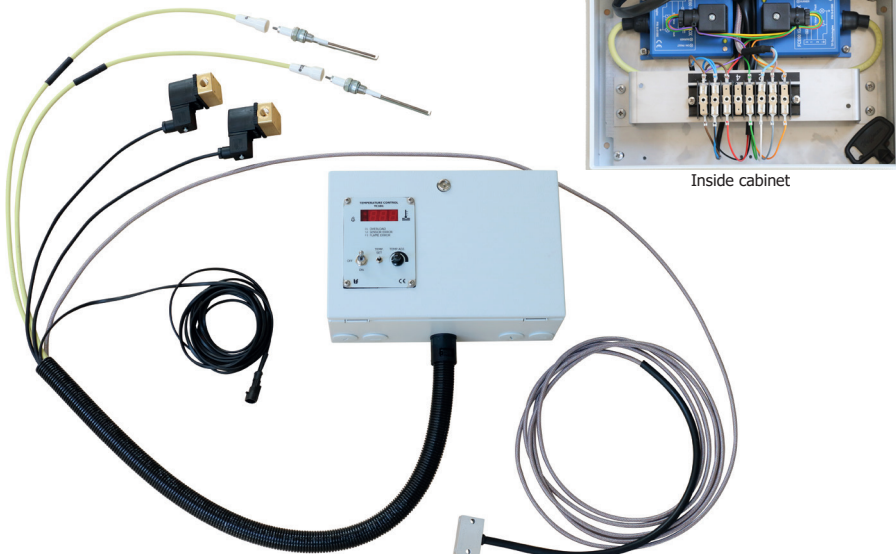

Fig. 10 - Example of complete Temperature Control System fully integrated in closed cabinet designed specifically to the specifications of the manufacturer, ready for delivery from TF-Technologies

Configuration

TF-Technologies offers three different temperature controllers that can be integrated in such a Temperature Control System with FCE60.



TC101



SC5-96



STC1600

Key specifications

- Temp. range 20-90°C or 50-175°C
- 1 Burner
- 1 Temperature sensor
- No manual override

- Temp. range 50-160°C
- 4-8 Burners
- 1 Temperature sensor
- Manual override

- Temp. range 130-180°C
- 8 Burners
- 4 Temperature sensors
- Manual override

For a complete guide to functionality of the temperature controllers, please refer to their individual user manual



Note that only specific versions of the TC101, SC5-96 and STC1600 comply with the 009/142/EC Gas Appliances Directive and the 2006/42/EC Machinery Directive. Contact TF-Technologies for information, or refer to the data sheet of the individual part numbers for this specification

The temperature controllers from TF-Technologies can only be used in Temperature Control Systems, where the temperature controller itself is not designed to work as a safety device. This is the case, where the Temperature Control System is designed to prevent explosions by maintaining material temperature below a certain threshold (e.g. maintaining temperature of a bituminous material to prevent explosion).



The temperature controllers from TF-Technologies can only be used in systems where the temperature controller itself is not designed to work as a safety device

For such an application, it is possible to use an alternative temperature controller approved specifically to such an application and assemble the Temperature Control System locally.

For the gas burner system to comply with the gas regulations of the 2009/142/EC Gas Appliances Directive and the 2006/42/EC Machinery Directive, only approved components as



described in this manual must be used and the system must only be configured and installed as described in the following sections. The alternative temperature controller must comply with the following safety specifications.



If an alternative temperature controller is used it may not allow automatic re-start of the FCE60 Ignition Box(es) from its flame failure mode



If an alternative temperature controller is used with a turning knob, the turning knob must have a locking function



If an alternative temperature controller is used, the temperature controller must be able to handle an error signal

The Temperature Control System must also be configured so that it is the FCE60 that controls the gas solenoid valves, and not the temperature controller.



The Temperature Control System must be configured so that the FCE60 controls the gas solenoid valves directly

Temperature Control System with a single burner

The most basic configuration with the FCE60 Ignition Box in a Temperature Control System is a configuration with one single burner. This configuration is displayed in figure 11 for an NPN controlled temperature controller and in figure 12 for a PNP controlled controller. The difference from the Ignition Control System with a single burner is that the temperature controller controls when and for how long the FCE60 is turned on, which determines the frequency and duration of the flame presence.

Configuration

The most basic configuration with the FCE60 Ignition Box in a Temperature Control System is a configuration with one single burner. This configuration is displayed in figure 11 for an NPN controlled temperature controller and in figure 12 for a PNP controlled controller. The difference from the Ignition Control System with a single burner is that the temperature controller controls when and for how long the FCE60 is turned on, which determines the frequency and duration of the flame presence.

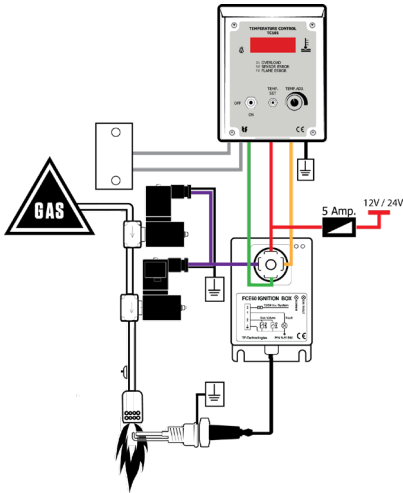

Fig. 11 - FCE60 Ignition Box in Temperature Control System configuration with one single burner and a NPN controlled temperature controller, e.g. TC101 or SC5-95

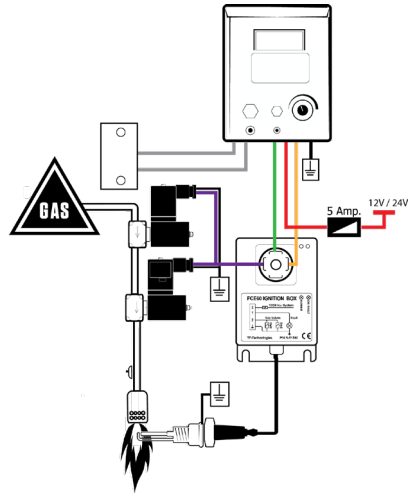

Fig. 12 - FCE60 Ignition Box in Temperature Control System configuration with one single burner and a PNP controlled temperature controller



The Temperature Control System must be designed with two gas solenoid valves connected serially to the gas supply to comply with the gas regulations of the 2009/142/EC Gas Appliances Directive and the 2006/42/EC Machinery Directive



A fuse of minimum 5A for overcurrent protection must be installed between the power supply and the FCE60 Ignition Box



The TC101 and SC5-95 Controllers are applicable in the NPN configuration

Temperature Control System with up to four burners

The Temperature Control System with the FCE60 in a configuration with multiple burners up to a total of four burners is displayed in figure 13 for an NPN controlled temperature controller and in figure 14 for a PNP controlled controller.

One FCE60 Ignition Box per burner is required and they must be serially supplied to ensure the safety of the gas system in case any one of the FCE60 detects a flame error. Serially supplied entails that the first FCE60 Ignition Box is connected to the power supply, the next FCE60 is supplied via the gas valve output of the first FCE60 and so on. The last FCE60 in the series supplies the two gas valves that are connected to this FCE60 in parallel.

All flame error outputs of the FCE60 Ignition Boxes must be connected to the flame error input of the controller in parallel.

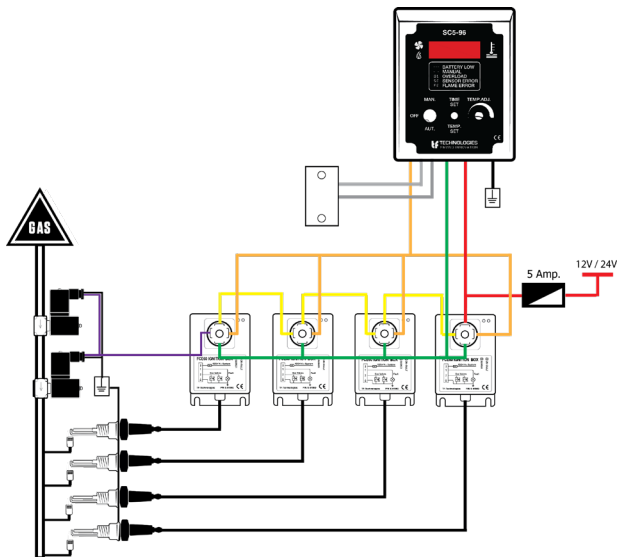

Fig. 13 - Temperature Control System configuration with FCE60 Ignition Boxes and up to four burners, and a NPN controlled temperature controller, e.g. SC5-95

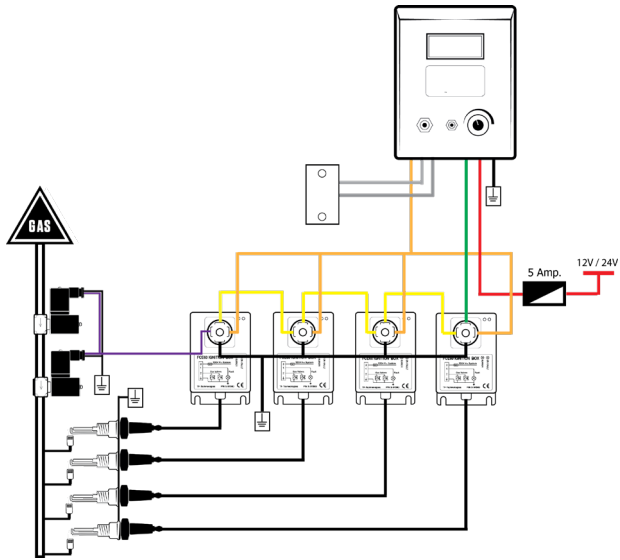

Fig. 14 - Temperature Control System configuration with FCE60 Ignition Boxes and up to four burners, and a PNP controlled temperature controller

In order to allow sufficient time for the first FCE60 to ignite the gas and detect the flame, no more than four FCE60 Ignition Boxes should be connected serially. For more information, refer to p. 21, Ignition Control System (stand-alone) with up to four burners.



The Temperature Control System should be configured so that no more than four FCE60 Ignition Boxes are connected serially to the gas solenoid valves

If you have problems maintaining functionality with less than four serially connected FCE60, we first recommend trying to optimize the spark plug position, please refer to section [x]. If it is still not possible to obtain a functional system, the system must be reconfigured as a Temperature Control System with more than four burners, but with fewer FCE60 in each series.

Be aware that the number of gas burners and FCE60 Ignition Boxes that can be connected in a series to a burner output of a temperature controller can be further limited by the maximum power consumption of the burner output.



Check with the manual of the temperature controller that the total calculated power consumption of the configuration fall within the specifications of the temperature controller



The TC101 and SC5-95 Temperature Controllers are applicable in configurations with up to four FCE60 Ignition Boxes in one series (to one burner output) , the STC1600 is limited to two FCE60 Ignition Boxes per series (burner output)

Just as in the single-burner configuration system, two gas valves must be connected serially to the gas supply for a sufficiently safe gas system.



The Temperature Control System must be designed with two gas solenoid valves connected serially to the gas supply to comply with the gas regulations of the 2009/142/EC Gas Appliances Directive and the 2006/42/EC Machinery Directive



A fuse of minimum 5A for overcurrent protection must be installed between the power supply and the FCE60 Ignition Boxes

Temperature Control System with more than four burners

Because the number of FCE60 Ignition Boxes that can be connected serially to the gas solenoid valves is limited to four by the FCE60 or fewer by the temperature controller, a temperature control system configuration with more burners, requires an additional series of FCE60 Ignition Boxes. Each series must still be connected to two gas solenoid valves, and all gas solenoid valves must be serially connected to the gas supply before all burners to ensure the safety of the gas system in case any one of the FCE60 detects a flame error. All flame error outputs of the FCE60 Ignition Boxes must be connected to the flame error input of the controller in parallel.

A Temperature Control System with FCE60 Ignition Boxes in a configuration with up to eight burners, is displayed in figure 15 for an NPN controlled temperature controller, and figure 16 for a PNP controlled controller.

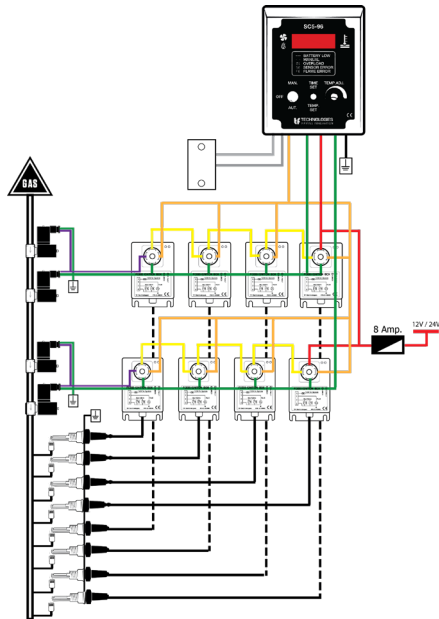

Fig. 15 - Temperature Control System with FCE60 Ignition Boxes in a configuration with up to eight burners, and an NPN controlled temperature controller, e.g. an SC5-96 with two burner outputs

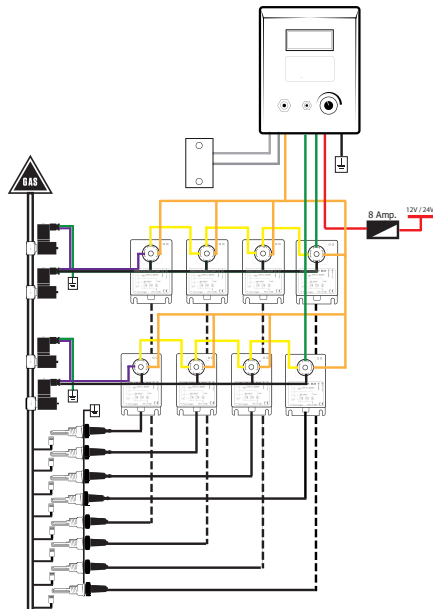

Fig. 16 - Temperature Control System with FCE60 Ignition Boxes in a configuration with up to eight burners, and an PNP controlled temperature controller



To comply with the gas regulations of the 2009/142/EC Gas Appliances Directive and the 2006/42/EC Machinery Directive, each series of FCE60 in a Temperature Control System must connect to two gas solenoid valves connected serially to the gas supply



A fuse of minimum 8A for overcurrent protection must be installed between the power supply and the temperature control system configuration

Be aware that the number of series of FCE60 Ignition Boxes that can be connected to a temperature controller is limited by the number of burner outputs available on the temperature controller, and the maximum power consumption of each individual burner output. The total number of FCE60 Ignition Boxes that can be connected to a temperature controller is also limited by the total maximum power consumption of the controller and the battery capacity.



How many series of FCE60 that can be connected to a temperature controller is limited by the number of burner outputs on the controller and the max power consumption of each individual burner output



Check with the manual of the temperature controller that the total calculated power consumption of the configuration fall within the specifications of the temperature controller



Check that the battery capacity is sufficient for the Temperature Control System configuration



The SC5-95 Temperature Controller with two burner outputs from TF-Technologies is applicable in this configuration with up to eight FCE60 Ignition Boxes

Temperature Control System with more than one temperature sensor and up to eight burners

A Temperature Control System with FCE60 Ignition Box can be configured with more than one temperature sensor. This is advantageous if environmental factors can affect the temperature of the measured area differently, e.g. different sections of a screed are impacted differently by a draft wind.

To maintain a stable temperature in the total measured area, a temperature controller with several temperature sensors can be applied in a Temperature Control System with FCE60 Ignition Boxes.

The STC1600 Temperature Controller from TF-Technologies can be used in such a configuration, and will typically be delivered as a complete Temperature Control System fully integrated in a closed cabinet with all connections assembled in a central terminal and designed specifically to the specifications of the individual manufacturer.

A Temperature Control System configuration with a STC1600 Temperature Controller with four temperature sensors and FCE60 Ignition Boxes for up to eight burners is displayed in figure 17.

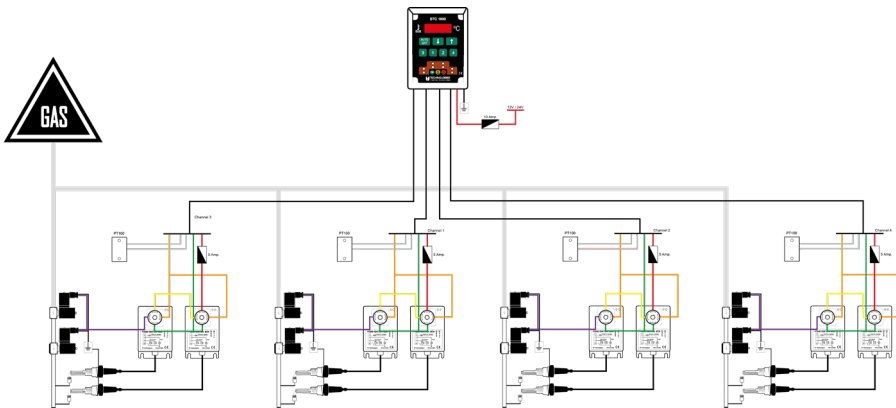

Fig. 17 - Temperature Control System with STC1600 Temperature Controller with four temperature sensors and FCE60 Ignition Boxes for up to eight burners



The STC1600 Temperature Control System should be configured so that no more than two FCE60 Ignition Boxes are connected serially to the gas solenoid valves



To comply with the gas regulations of the 2009/142/EC Gas Appliances Directive and the 2006/42/EC Machinery Directive, each series of FCE60 in a Temperature Control System must connect to two gas solenoid valves connected serially to the gas supply



A fuse of minimum 10A for overcurrent protection must be installed between the power supply and the temperature control system configuration



Check that the battery capacity is sufficient for the Temperature Control System configuration



Installation

Essential components for installation	41
Installing the FCE60 Ignition Box.....	45







Essential components for installation

For the installation of the FCE60 Ignition Box the following key components are required. The components are available from TF-Technologies with the part numbers specified. See data sheets in Appendix.

For the gas burner system to comply with the gas regulations of the 2009/142/EC Gas Appliances Directive and the 2006/42/EC Machinery Directive, only components approved as described here can be used.

Gas Solenoid Valves



Gas valves with a suitable voltage and pressure specification to the gas burner system in question must be used. EN 161 certified gas valves are required for systems with a gas pressure up to 5 bar. The following EN 161 certified gas valves are available from TF-Technologies.

Part number		
S-50042		Gas Solenoid Valve 0-5 bar, 12V
S-50043		Gas Solenoid Valve 0-5 bar, 24V
S-50044		Gas Solenoid Valve 0-3 bar, 12V
S-50045		Gas Solenoid Valve 0-3 bar, 24V

For systems with a gas pressure >5 bar, the gas valves must comply with EN 16678. Contact TF-Technologies for information on availability.

Gas Spark Plugs

One or more Spark Plugs is required for igniting the gas and measuring the ionization current to monitor flame presence. To comply with the dimensions of different gas burner systems, three lengths are available from TF-Technologies.

Part number		
S-50008		Gas Spark Plug 35mm
S-50133		Gas Spark Plug 50mm
S-50009		Gas Spark Plug 100mm

Accessories

The Thread Mount is used to mount the Spark Plug and ensure solid ground.

Part number		
S-50067		Thread Mount Ø18mm / 0.71in

High Tension Cords

One or more High Tension Cords is required to connect the FCE60 to the Spark Plug(s). The high tension cord must feature a noise resistor and comply with general safety principles for wiring and conductors as described in EN 60445. The High Tension Cords from TF-Technologies are available in various cable lengths and can be used in all the system configurations illustrated in this manual. For larger systems, cabling must be reconfigured as described in EN 60445.













Part number		
S-50007/x,x		High Tension Cord With ceramic cap, noise resistor, BMW connector and rubber cap x,x is cable length

Cable components for local assembly are also available from TF-Technologies. See Appendix for part numbers and guide to assembly.



Connector with Gasket

The Connector with Gasket is used for setting up the interface to the gas burner system.

Part number																	
S-50070		Connector with Gasket 4-Pin Connector															
Wiring colour codes	<table border="1"> <thead> <tr> <th>Pin number</th> <th>Wire colour</th> <th>Function</th> </tr> </thead> <tbody> <tr> <td>1</td> <td>Orange </td> <td>Flame error</td> </tr> <tr> <td>2</td> <td>Purple </td> <td>Gas valves</td> </tr> <tr> <td>3</td> <td>Red </td> <td>Supply (12/24VDC)</td> </tr> <tr> <td>4</td> <td>Green </td> <td>Ground</td> </tr> </tbody> </table>		Pin number	Wire colour	Function	1	Orange 	Flame error	2	Purple 	Gas valves	3	Red 	Supply (12/24VDC)	4	Green 	Ground
Pin number	Wire colour	Function															
1	Orange 	Flame error															
2	Purple 	Gas valves															
3	Red 	Supply (12/24VDC)															
4	Green 	Ground															

Extra components for Temperature Control Systems

When the FCE60 is integrated in a Temperature Control System, the system is typically delivered fully assembled and integrated in a closed cabinet from TF-Technologies to ensure full compliance to the European gas safety regulations.

If, however, the system is configured locally, the following additional essential components are available from TF-Technologies.

Pt-100 Temperature Sensor



















The Pt-100 Temperature Sensor(s) is required to supply the Temperature Controller with temperature inputs

Part number		
S-50019/0,7 S-50019/3,0 S-50019/5,0 S-50019/6,5		Pt-100 Temperature Sensor -25° to 200° C / -13° to 392° F Available in 0,7m, 3m, 5m, 6,5m cable lengths

Temperature Controller

The Temperature Controller is required to control the frequency and duration of the supply to the connected FCE60 Ignition Box(es). The TC101 Temperature Controller is available from TF-Technologies in two versions with different temperature intervals.

For SC5-96 and STC1600 Temperature Controllers with additional functionality, contact TF-Technologies.

Part number																										
S-50121		TC101 Temperature Controller 50° to 175° C / 122° to 347° F																								
S-50122		TC101 Temperature Controller 20° to 90° C / 68° to 194° F																								
Wiring colour codes		<table border="1"> <thead> <tr> <th>Pin number</th> <th>Wire colour</th> <th>Function</th> </tr> </thead> <tbody> <tr> <td>0</td> <td>Orange </td> <td>Flame error</td> </tr> <tr> <td>1</td> <td>Grey </td> <td>Pt-100 (pin 1)</td> </tr> <tr> <td>2</td> <td>White </td> <td>Pt-100 (pin 2)</td> </tr> <tr> <td>3</td> <td>Green </td> <td>Burner output</td> </tr> <tr> <td>4</td> <td>-</td> <td>Not connected</td> </tr> <tr> <td>5</td> <td>Red </td> <td>Supply (12/24VDC)</td> </tr> <tr> <td>6</td> <td>Black </td> <td>Ground</td> </tr> </tbody> </table>	Pin number	Wire colour	Function	0	Orange 	Flame error	1	Grey 	Pt-100 (pin 1)	2	White 	Pt-100 (pin 2)	3	Green 	Burner output	4	-	Not connected	5	Red 	Supply (12/24VDC)	6	Black 	Ground
Pin number	Wire colour	Function																								
0	Orange 	Flame error																								
1	Grey 	Pt-100 (pin 1)																								
2	White 	Pt-100 (pin 2)																								
3	Green 	Burner output																								
4	-	Not connected																								
5	Red 	Supply (12/24VDC)																								
6	Black 	Ground																								



Note that other versions of the TC101 Temperature Controller with different part numbers than those stated above may not comply with the 2009/142/EC Gas Appliances Directive and the 2006/42/EC Machinery Directive. Refer to the data sheet for the specific part number for clarification.



1.
2.
3.

Installing the FCE60 Ignition Box

The following instruction for installation should be observed for installation of the FCE60 Ignition Box, regardless of whether the Ignition Control System/Temperature Control System is configured locally or delivered fully assembled and integrated in a closed cabinet from TF-Technologies.



When installing an Ignition Control System or Temperature Control System, ensure that the system is installed in such a way that any moveable parts and high temperature areas of the machine or appliance will not harm the system



When installing an Ignition Control System or Temperature Control System, take ergonomical aspects related to daily use, maintenance and service into account



Turn off power supply before commencing installation



Ensure that the Ignition Control System or Temperature Control System is connected to a switched power supply, so that the system powers up with the machine or appliance. The system must not be connected directly to the battery.

Alternatively, install a switch before the system to turn it on and off

1 Weld Thread Mount onto system

If the gas burner system does not already contain a suitable thread for mounting the Spark Plug, the Thread Mount should be welded onto the system in a suitable location.



The thread used for mounting must be welded solidly onto the system, as it is vital that the Spark Plug is properly grounded to control the sparking



The thread Mount must be positioned to ensure that the tip of the Spark Plug is positioned in the hottest part of the flame, i.e. the center of the blue part of the flame

2 Mount Spark Plug

Mount the Spark Plug in the Thread Mount.
Ensure that the Spark Plug is positioned correctly.



It is important that the Spark Plug is positioned correctly to be able to perform flame detection. The correct position is with the tip of the Spark Plug in the center of the blue part of the flame.

To optimise the response time of the FCE60, it is important to get the maximum ionization current possible from the Spark Plug. The best result is accomplished by measuring the ionization current for different adjustments of the Spark Plug position, when the system is configured for the first time.

This can be done safely with a Spark Plug Position Test Box available from TF-Technologies. Contact us for more information.

3 Mount FCE60 Ignition Box

Mount the FCE60 Ignition Box on a plane surface, preferably so that the two LEDs displaying operation modes are visible.



The FCE60 can be mounted in a cabinet to shield it from heat, dust and condensation. Ambient temperature must not exceed 70°C / 158°F

Alternatively, mount fully-fitted cabinet with Ignition Control System or Temperature Control system as delivered by TF-Technologies in a suitable location

4 Connect High Tension Cord

Push the ceramic spark plug cap of the cable onto the Spark Plug, and the BMW Connector in the other end onto the FCE60 in the bottom, and pull up the rubber cap to provide the isolation required at the high voltage output of the FCE60 (FCE60 already connected in fully-fitted cabinet).



Organize the cable so that it can reach the FCE60 or cabinet without being in the way of any moveable parts.

5 Mount Pt-100 Sensor (if applicable)

If the configuration is a Temperature Control System, the Pt-100 Temperature Sensor should be mounted in a suitable position. Organize the cable so that it is not in the way of any moveable parts.



Ensure that the Pt-100 Temperature Sensor is installed in a position, where it is able to measure the correct, relevant temperature, without exceeding its temperature specification. Maximum ambient temperature is 200°C / 392°F

6

Mount Gas Valves

Mount the Gas Solenoid Valves on the gas pipes, while observing best practice for installation, ensuring that gas pipes are completely tight and no gas seepage is possible.

7

Perform wiring as described for the relevant configuration

Perform all wiring of the system for the relevant configuration, as described in the section Configuration p. 18.



The wiring and installation of the FCE60 in an Ignition Control System or Temperature Control System must be undertaken in compliance with best practice for installation as described in EN 60204-1



All cabling in the installation of the Ignition Control System or Temperature Control System must comply with EN 60445

Use the Connector with Gasket to connect wires to the FCE60. Refer to colour-codes on p. 38. For pin 2, one wire for each Gas Valve is required. For pin 1, it is possible to connect a lamp, if an error indication is desired apart from the red LED on the FCE60 Ignition Box.













The current consumption from the gas solenoid valve output of the FCE60 Ignition Box must not exceed 2.5 Amp. If using other gas valves than those on p. 36, the current consumption must be checked prior to installation to avoid damaging the FCE60 Ignition Box



The current consumption drawn from the flame error output must not exceed 1 Amp.

Refer to colour-codes on p. 39 for installation of TC101 Temperature Controller. The interfacing between the FCE60 Ignition Box and TC101 Temperature Controller should be set up as the following:

TC101 Temperature Controller			FCE60 Ignition Box			Interface function
Pin number	Wire colour		Pin number	Wire colour		
0	Orange		1	Orange		Flame error input from FCE60 to TC101
1	Grey					TC101 measures Pt-100 variable temperature resistor value
2	White					
3	Green			Green		TC101 supplies ground to FCE60
4	-					
5	Red		3	Red		Supply (12/24 VDC)
6	Black					Ground from gas burner system
			2	Purple		Gas valve supply from FCE60 (12/24 VDC)

If an alternative temperature controller is used, refer to its manual for correct wiring.

Alternatively, if a fully-fitted cabinet with an Ignition Control System or Temperature Control System with FCE60 delivered by TF-Technologies is installed, it will already comply with all of the above standards, and all wiring as described in this step 7 is not required.



Mount fuse as described for the relevant configuration

Before the system is connected to the power supply, mount a fuse as specified for the relevant configuration in the section Configuration on p. 18.



Any fully-fitted cabinet with an Ignition Control System or Temperature Control System with FCE60 delivered by TF-Technologies does not include this fuse. The fuse must be mounted separately outside the cabinet

9 **Connect system to switched power supply and check functionality**
Connect the system to the power supply and turn on power to check functionality. The yellow LED of the FCE60 should flash once, and the other LED should turn green. Refer to Troubleshooting section on p. 54 in case of problems.



For Temperature Control Systems remember to also turn on the temperature controller. Temperature controllers from TF-Technologies will start up in off mode.



Safety Instruction

Requirement for the gas burner system	52
Correct use	54
Incorrect use	56
Warnings and Dangerous Situations.....	57

Requirements for the gas burner system

It is a pre-condition for the safe use of the FCE60 Ignition Box in accordance with applicable safety regulations that the FCE60 is only used in gas burner systems that comply with statutory safety regulation.

There are two categories of key safety requirements for gas burner systems that have an influence on the safe use of the FCE60 Ignition Box.

Gas burner systems in general must meet the safety requirements specified in 2009/142/EC Gas Appliances Directive (GAD).

Gas burner systems installed on machinery must meet the requirements specified in 2006/42/EC Machinery Directive (MD) in addition to the requirements under the first category.

Key safety requirements for gas burner systems in general for safe use and installation of the FCE60 Ignition Box



The gas burner system and any individual components herein, including gas appliances, fittings, gas connecting hoses, gas valves and regulators must comply with the relevant requirements of GAD. Inappropriate equipment may give rise to dangerous situations and serious personal injury due to gas leaks.



Combustion emissions such as CO and CO² must be kept below a level that ensures no danger for personnel. This should be done by either ventilation or proper safety devices



The FCE60 Ignition Box must be installed, mounted and connected in accordance with the instructions in this user manual



The FCE60 Ignition Box must be installed so that it is accessible and protected against harmful effects



A fuse for overcurrent protection must be installed between the power supply of the gas burner system and the FCE60 Ignition Box(es). This should be checked prior to the connection of the system.

The short circuit breaking capacity must be adapted to the total maximum power consumption of all the FCE60 Ignition Boxes and gas valves in the configuration, or equal the prospective fault current in case of short-circuiting.

Additional key safety requirements for gas burner systems on machinery for safe use and installation of the FCE60 Ignition Box



The machinery must comply with the relevant requirements of MD, specifically the requirements described in EN 60204 *Safety on Machinery - Electrical Equipment on Machines*



The machinery must be equipped with an emergency stop that can stop all potentially dangerous parts of the machine, including switching off the power supply to the FCE60 Ignition Box



FCE60 Ignition Box is designed for use on machinery with a 12V DC or a 24V DC system. The machinery must be able to deliver a stable power supply, for instance via the machine battery. Such a battery power supply must avoid power loss for more than 5 ms and maintain a supply within 0.85 to 1.15 times the nominal voltage (0.7 to 1.2 times the nominal voltage for battery powered vehicles)



After installing the FCE60 Ignition Box, it must be tested that the emergency stop covers the power supply to the FCE60 Ignition Box so that it is switched off, when the emergency stop is activated

Correct use

The FCE60 Ignition Box is an ignition controller designed for use in gas burner systems for controlling and monitoring the gas flow and gas ignition. Correct use therefore entails that the Ignition Box is used for this purpose.

The FCE60 Ignition Box must only be installed by electrically trained personnel with training in gas safety, so that personal injury and damaged equipment is avoided.



Read and understand the user manual. In case of questions, contact your local representative



Be aware of the situations described under Examples of Incorrect Use p. 49, Warnings and Dangerous Situations p. 50 and be able to avoid them



Be aware of the technical specifications of the FCE60 Ignition Box and ensure it is installed correctly and only within its technical specifications



Make sure a total risk assessment of the gas burner system is made accessible to everyone who will be working with and around the gas system, so they are made aware of how to avoid the dangerous situations identified



Investigate local health and safety regulation concerning the operation of the gas burner system, and incorporate any risks involved in the use of hot surfaces in the total risk assessment of the system. Particular attention needs to be paid to any gas risks that components of the system may introduce separately or in combination with other parts



Make sure all personnel who will be working with and around the gas burner system are made aware of how the FCE60 Ignition Box affects the system



Inform the operator of the gas system of all the relevant safety instructions contained in this manual



Ensure the FCE60 Ignition Box is not damaged



Inform TF-Technologies or your local representative, if the FCE60 Ignition Box for any reason is not safe to use

Incorrect Use

The FCE60 Ignition Box should only be used for the purpose it is constructed to, and most examples of incorrect use are self-explanatory and not described.

However, certain key examples of misuse or inappropriate behaviour are outlined below, and should be avoided.



Do not use unauthorised system configurations, as this can damage the FCE60 Ignition Box and lead to unpredictable flame and gas control, which may result in serious personal injury or material damage.



Avoid contact with the high tension cable, spark plug or high voltage output thread of the FCE60 Ignition Box, when the system is powered on



No parts of the FCE60 Ignition Box must be rebuilt or refurbished, as TF-Technologies will no longer be able to vouch for the quality, and rebuilding units may cause serious personal injury or material damage



Do not use unauthorised cables or unauthorised spare parts, as this can damage the FCE60 Ignition Box and lead to unpredictable flame control and monitoring, which may result in serious personal injury or material damage



Do not connect the FCE60 Ignition Box, when power is already applied, as it can lead to serious personal injury



The FCE60 Ignition Box is only for use on gas burner systems. Do not use the FCE60 on other types of burner systems



Warnings and Dangerous Situations



Do not use the FCE60 Ignition Box if it is obviously damaged



Do not use the FCE60 Ignition Box if it shows signs of unauthorized repair



Do not use the FCE60 Ignition Box if it is connected an incompatible voltage supply, spark plug, gas valve or temperature controller



Do not connect the FCE60 Ignition Box to a gas burner system that uses other types of input than the output the FCE60 is able to deliver.



Do not install or use the FCE60 Ignition Box in dangerous areas or in dangerous atmospheres or at dangerous pressure levels, as the FCE60 is not designed to such operation



Maintenance

Service and Repair	59
Transport.....	59
Storage	60
Cleaning	60
Disposal	60

Service and Repair

In case of problems with the FCE60 Ignition Box, please refer to p. 54 Troubleshooting for answers to the most common problems. If problems persist, contact TF-Technologies or your local representative for assistance



Do not attempt to repair the equipment yourself. Replacement of connectors or any other parts must be undertaken by TF-Technologies or an appointed service representative of TF-Technologies. Contact your local representative for further information



Service and repairs of the FCE60 Ignition Box, cables or other parts undertaken by anyone else than TF-Technologies or an appointed service representative of TF-Technologies can result in serious personal injuries and/or damaged equipment

Transport



Visually inspect the the FCE60 Ignition Box, cable and accessories upon receipt. Make sure all items are intact, and the serial number is engraved and the temperature label attached to the FCE60 Ignition Box



If parts of the FCE60 Ignition Box, cable or accessories are damaged at reception, we recommend you to:

- Reject the package if it is visibly damaged (regress)
- Document any potential damage in the form of text and pictures
- Inform seller of the damages
- Do not use damaged products

Storage



Keep the FCE60 Ignition Box, cable and accessories dry and out of direct sunlight for long term storage



Store the FCE60 Ignition Box, cable and accessories within their storage temperature range. Note that the storage temperature range for the FCE60 is different from some of the accompanying parts. Everything can be stored together at a storage temperature of -40°C to 85°C / 14°F to 185°F

Cleaning

It is not necessary to clean the the FCE60 Ignition Box to maintain functionality, but it can be cleaned for cosmetic reasons. If cleaning the FCE60 Ignition Box or accompanying cable and parts, it is important to use appropriate cleaning agents. Inappropriate cleaning agents or an incorrect cleaning method can damage the equipment and cause degrading or loss of functionality.

We recommend benzine (cleaner's naphtha) as cleaning agent due to its effectiveness and quick evaporation. Please note that benzine is an organic solvent, which is flammable and harmful to health and environment. Use it responsibly and with respect for its harmful effects.



Follow the instructions on the bottle of benzine



Use as little as possible



Avoid breathing vapors and direct contact with the skin



Never use cellulose thinner or acetone, as they dissolve paint and plastic respectively, which will degrade functionality. Other cleaning agents can also be harmful, but experience shows these two in particular should be avoided



Be careful to not remove the temperature label, as it must remain intact or warranty will be void



Use of benzine to clean the High Tension Cables can make the writing on the cables disappear, but the cables will not be damaged

Disposal

When disposing the FCE60 Ignition Box the equipment must be treated as electronic waste in compliance with the local regulations of the country in which the equipment is disposed. The responsibility for safe and appropriate disposal is transferred to the buyer in the sale of the FCE60 Ignition Box.



Appendix

Trouble-shooting	63
Local Assembly of High Tension Cord	64
Technical Specifications (data sheets)	66
Certificate	72
Declaration of Conformity	73







Troubleshooting

Symptom	Probable Cause	Appropriate Action
<p>Within first 4 seconds of power up: One of the FCE60 Ignition Boxes does not turn on turn on its green LED</p>	Poor connection to FCE60	<ul style="list-style-type: none"> • Check connections around the given FCE60 • Change faulty wiring or connections
	Internal fault of FCE50	<ul style="list-style-type: none"> • Replace faulty FCE60
<p>After first 4 seconds of power up: One of the FCE60 Ignition Boxes turns on its red LED (shortly)</p>	Poor or empty gas supply	<ul style="list-style-type: none"> • Check for faulty gas pipes and gas connections and change where required • Check gas container
	Poor connection to FCE60	<ul style="list-style-type: none"> • Check connections around the given FCE60 • Change faulty wiring or connections
	Poor connection to external hardware	<ul style="list-style-type: none"> • Check connections to external hardware • Replace faulty external hardware
	Poor connection to gas valves	<ul style="list-style-type: none"> • Check supply and ground connection to gas valves • Change faulty wiring or connections to gas valves
	Internal fault of FCE60	<ul style="list-style-type: none"> • Replace faulty FCE60
	Burner problem	<ul style="list-style-type: none"> • Check burner for damage or dirt • Change or clear burner
	Defect gas valve	<ul style="list-style-type: none"> • Replace faulty gas valve
	Poor positioning of Spark Plug not in center of blue part of the flame	<ul style="list-style-type: none"> • Optimize Spark Plug position, e.g. using Spark Plug Position Test Box. Contact TF-Technologies for availability

Local Assembly of High Tension Cord

It is possible to purchase cable components from TF-Technologies and perform a local assembly of the High Tension Cord.

Required components

Part number		
S-50059/25		High Tension Cable 25m
S-50060		BMW Connector M4-thread connector
S-50113		Rubber Cap For insulation of BMW connector
S-50026		Noise Resistor 1K Ω noise resistor
S-50023		Ceramic Spark Plug Cap Woodscrew wire connection, 50mm
S-50234		Crimping Tool For mounting BMW Connector

Instruction for assembly

1.
2.
3.

- 1** Cut the High Tension Cable in the desired length.
- 2** Put the Rubber Cap on the High Tension Cable.
- 3** Strip off the isolation of the High Tension Cable leaving 3mm exposed core.
- 4** Push the BMW Connector onto the exposed core of the High Tension Cable. Use the Crimping Tool to crimp the thin part of BMW Connector around the exposed core.
- 5** Cut the High Tension Cable 30cm from the end without the BMW Connector.
- 6** Reassemble the High Tension Cable with the Noise Resistor by screwing the noise resistor into the core center of the cable without stripping it. The Noise Resistor is vital to avoid influence on other electronic equipment installed close by.
- 7** Screw the Ceramic Spark Plug Cap into the core center of the open end of the High Tension Cable. It is important to use a ceramic cap due to the high temperature exposure during the gas burn.

Technical Specifications (data sheet)

FCE60 Ignition Box



Ignition Box - EN 298:2012 certified FCE60 for Flame Control and Monitoring

The FCE60 Ignition Box is a certified gas safety component for use in any gas burner system. It controls the ignition of a gas burner and secures a continued safe operation.

The FCE60 controls the gas supply and ignites the gas, and monitors the flame throughout operation. Any accidental blow-out of the flame is immediately detected by the Ignition Box, and will trigger a re-ignition. In case of re-ignition failure, the FCE60 will shut off the gas supply to prevent accidents caused by gas leakage, and send out an error signal. The status of the operation of the burner is easily viewed at all times with red/green and yellow indicator lamps.

The FCE60 Ignition Box can be utilized in systems designed for permanent operation, but the Ignition Box should be shut off and restarted once every 24 hours as a safety measure, to allow the FCE60 to perform a start-up check and to ensure all functions are working.

The FCE60 Ignition Box can be used in systems with a maximum burner output of 360kW/channel.

The FCE60 Ignition Box is certified as a safety component to the standard EN 298:2012 Automatic Burner Control Systems for Burners and Appliances Burning Gaseous Fuels.

This ensures full compliance to the 2006/42/EC Machinery Directive and 2009/142/EC Gas Appliances Directive, when used in gas burner systems on machinery or in consumer appliances.

Tested to EN 13309:2010 Construction Machinery - Electromagnetic Compatibility of Machines with Internal Power Supply, the FCE60 is also in full compliance of the 2014/30/EU EMC Directive and CE marked.

The FCE60 Ignition Box is backwards compatible with the former non-certified FCE24 Ignition Box.

Ignition Box Specifications	
Part Number	S-51590
Power Supply	12/24 V (DC) System
Power Consumption	Typical at 24 VDC 120 mA Max. 400 mA
Dimensions (LxWxH)	105x70x40mm / 4.1x2.8x1.6in
Weight	250g / 0.6lbs
Storage Temperature	-40°C to 85°C / -40°F to 185°F
Operating Temperature	-10°C to 70°C / 14°F to 158°F
Valve Output	Max. 2.5 A
Flame Error Output	Max 1 A
Min. Spark Frequency	7 Hz
Flame Failure Response Time	<10 sec.
Flame Failure Detection Time	<1 sec.
Housing Protection Class	IP55
Internal Supply Voltage	11 Volt
Flame Detection	Ionization (not adjustable)
Ionization Current/Operation	>3 µA
Switch-off Sensitivity	<1 µA
Vibration Resistance	10 - 150 Hz 1 g rms
High Voltage Output Cable	High tension cord, up to 6m / 19.7ft, w. ceramic cap, noise resistor and BMW connector
Irreplaceable Internal Fuse	6 A
Mounting Options	On plane surface, angle irrelevant
Connections	1: Flame Error Output 2: Valve Output 3: 12/24V (DC) w. extern. 5A Fuse. ⊥ : Ground (GND)



The FCE60 Ignition Box



Ignition Box with High Tension Cord, Noise Resistor and Spark Plug

TF-Technologies reserves the right to make changes without further notice.

w. HB12003 Page 1/2

FCE60 Ignition Box

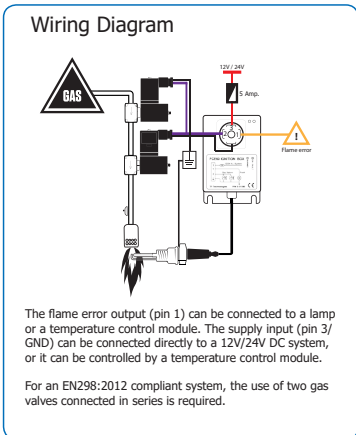
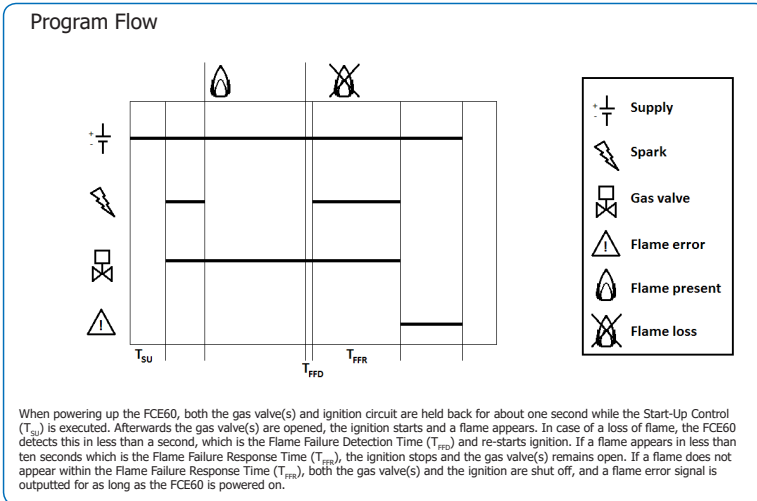

Status Indicators

Operation Mode	BURNER	ON/FAULT
Turned off	○ ○	
Start-up	● (Dim) ●	
Igniting	○ ●	
Running (flame on)	● ●	
Flame failure	○ ●	●

TF-Technologies reserves the right to make changes without further notice.

v. H812003 Page 3/2

Gas Solenoid Valves



Gas Solenoid Valve - (0 - 5 bar EN161 approved) 12 or 24 Volt

Electromagnetic gas valve for controlling the gas flow in a gas system. The gas valve is EN161 approved.

This approval is required for gas valves in automatic burner control systems required to comply with 2006/42/EC Machinery Directive or 2009/142/EC Gas Appliances Directive.

For 2006/42/EC or 2009/142/EC compliance, two gas valves connected serially to the gas supply are required.

To comply with these directives, the automatic burner control system further requires an ignition controller certified as a safety component, such as the S-51590 FCE60 Ignition Box certified to EN 298:2012.



Gas Solenoid Valve	
Part number	S-50042 (12V) S-50043 (24V)
Gas Input Thread	G1/4i
Gas Output Thread	G1/4i
Power consumption	8 W
Without power	Valve closed
Dimensions (HxLxW)	72x49x45mm / 2.8x1.9x1.8in
Weight	450g / 1lbs
Housing material	Brass
Installation position	Arbitrary
Operating temperature	-15°C to 60°C / 5°F to 140°F
IP Class	IP 65
Max gas pressure	5 bar
Connector	Valve plug A-type DIN 43650

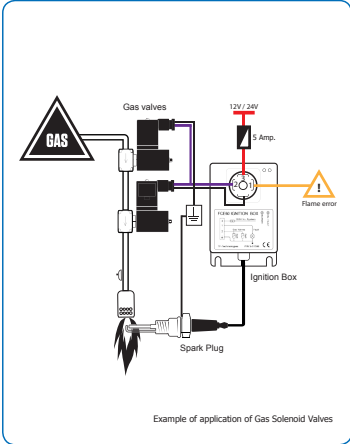

v. HB14301

TF-Technologies A/S
Kratbjerg 214

DK-3480 Fredensborg
Phone: +45 4848 2633

www.tf-technologies.com
sales@tf-technologies.com

Gas Solenoid Valves



Gas Solenoid Valve - (0 - 3 bar EN161 approved) 12 or 24 Volt

Electromagnetic gas valve for controlling the gas flow in a gas system. The gas valve is EN161 approved.

This approval is required for gas valves in automatic burner control systems required to comply with 2006/42/EC Machinery Directive or 2009/142/EC Gas Appliances Directive.

For 2006/42/EC or 2009/142/EC compliance, two gas valves connected serially to the gas supply are required.

To comply with these directives, the automatic burner control system further requires an ignition controller certified as a safety component, such as the S-51590 FCE60 Ignition Box certified to EN 298:2012.



Gas Solenoid Valve	
Part number	S-50044 (12V) S-50045 (24V)
Gas Input Thread	G1/4i
Gas Output Thread	G1/4i
Power consumption	8 W
Without power	Valve closed
Dimensions (HxLxW)	68x66x27mm / 2.7x2.6x1.1in
Weight	250g / 0.6lbs
Housing material	Brass
Installation position	Arbitrary
Operating temperature	-15°C to 60°C / 5°F to 140°F
IP Class	IP 54
Max gas pressure	3 bar
Connector	Valve plug B-type DIN 43650

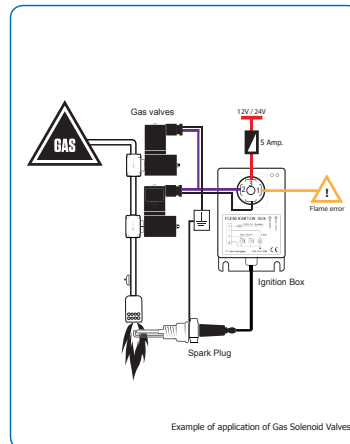

v. HB 14203

TF-Technologies A/S
Kratbjerg 214

DK-3480 Fredensborg
Phone: +45 4848 2633

www.tf-technologies.com
sales@tf-technologies.com

Pt-100 Temperature Sensor



Pt-100 Temperature Sensor for Paving Screeds

The Pt-100 sensor is a temperature input sensor for the SC5-96 and STC1600 systems.

The sensor is a platinum RTD (resistance temperature detector) sensor, which measures temperature by correlating the resistance of the RTD element with temperature.

The advantages of platinum resistance temperature sensors include:

- High accuracy
- Low drift
- Wide operating range
- Suitability for precision applications

The unit is specifically designed to withstand the tough working conditions of the construction industry.



Pt-100 Temperature Sensor Specifications	
Part number	S-50019/x,x (x,x is cable length in meters)
Application	Temperature sensor for paving screeds
Operating temperature	-25°C to +200°C
Storage temperature	-40°C to +200°C
Sensor type	Pt-100 DIN B
Cable type	Silicone insulated cable 2 x 0.75 mm ² with galvanized steel wire braiding
Sensor house	Aluminium with 6.3mm mounting holes
Connector	No plug

TC101 Temperature Controller



TC101 Temperature Controller 1 Channel Temperature Controller for Gas Heating

The TC101 Temperature Controller is the user-interface for the TC101 temperature control systems. It is designed to automatically maintain the correct operating temperature of asphalt containers/hotboxes or other related equipment throughout operation without overheating the bitumen.

The TC101 Temperature Controller provides the ability to adjust the temperature to the desired temperature on the turning knob. Once the desired temperature is set, the TC101 Temperature Controller automatically maintains this temperature. It is not possible to manually override the temperature set, but the system can be turned on/off on the switch.

The TC101 Temperature Controller is a single channel system monitoring the temperature via one connected Pt-100 temperature sensor. It regulates the temperature to the level set by the operator by turning the connected FCE60 Ignition Box ON/OFF. The ignition box controls the gasflow to maintain the desired temperature.

This version without automatic re-ignition is specifically designed to comply with the 2006/42/EC Machinery Directive.



TC101

TC101 Temperature Controller Specifications	
Part Number	S-50121 S-50122
Power Supply	12/24 Volt System (11-30 VDC)
Power Consumption	Typical at 24 VDC 80 mA Max. 200 mA
Dimensions (LxWxH)	121x90x45mm / 4.8x3.5x1.8in
Weight	350g / 0.8lbs
Storage Temperature	-40°C to 85°C / -40°F to 185°F
Operating Temperature	0°C to 60°C / 32°F to 140°F
Temperature Control Range	20°C to 90°C / 68°F to 194°F (S-50121) 50°C to 175°C / 122°F to 347°F (S-50122)
Auto Mode Available	Yes
Manual Mode Available	No
Burner Output	1x Temperature Controlled Output (max 3.5A)
Input	Pt-100 Temperature Sensor
Resolution	1°C
Connector	BLZ 5.08/7 SN OR



TC101 mounted in a cabinet

Certificate

Certificate



Number	91443/01	Replaces	--
Issued	09-03-2016	Scope	2009/142/EC(30-11-2009)
Report number	150700834	Contract number	E 7392
PIN	0063CR1834		

EC TYPE EXAMINATION CERTIFICATE (GAD)

Kiwa hereby declares that the Automatic Burner Control System , type

FCE60 Ignition Box

manufactured by

TF-Technologies A/S
Fredensborg, Denmark

meets the essential requirements as described in the
Directive 2009/142/EC relating to appliances burning gaseous fuels.
The compliance is based on examination to EN 298:2012.

The product has been approved for all EU and EFTA countries.

A description of the specific types is given in the appendix to this certificate.

Kiwa Nederland B.V.
Wimersdorf 50
P.O. Box 137
7300 AC APELDOORN
The Netherlands
www.kiwa.com

GASTEC



Luc Leroy
Kiwa

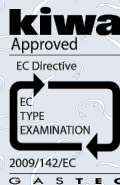

Declaration of Conformity



EC Declaration of Conformity
Document no.: J9006601
Published: June 29, 2016

EC Declaration of Conformity

Electromagnetic Conformity Directive 2004/108/EC

Manufacturer within European Community

COMPANY NAME TF-Technologies A/S
ADDRESS Kratbjerg 214
3480 Fredensborg
Denmark

Description of Product

PRODUCT NAME FCE60 Ignition Box
MODEL FCE60
APPLICATION Flame Control and Monitoring
PART NUMBER S-51590

Conformity and Assessment Procedure Followed

DIRECTIVE Electromagnetic Conformity Directive 2004/108/EC (EMC)
Gas Appliances Directive 2009/142/EC (GAD)

HARMONIZED STANDARD EN 298:2012 – Automatic burner control systems for burners and appliances burning gaseous or liquid fuels
EN 13309:2010 – Construction machinery
- Electromagnetic compatibility of machines with internal power supply

TEST METHOD ISO 7637-2 + 7637-3 CISPR 16-1
ISO 10605 CISPR 16-2
ISO 11452-2 CISPR 25

Additional Compliance

DIRECTIVE Machinery Directive 2006/42/EC (MD)

HARMONIZED STANDARD EN 60204-1:2006+A1:2009 – Safety of machinery
- Electrical equipment of machines: General requirements
EN 746-1 + A1:2009 – Industrial thermoprocessing equipment
- Common safety requirements for industrial thermoprocessing equipment
EN 746-2:2010 – Industrial thermoprocessing equipment
- Safety requirements for combustion and fuel handling systems
EN 746-3 + A1:2009 – Industrial thermoprocessing equipment
- Safety requirements for the generation and use of atmosphere gases

Valid if both installation and use follow the instructions of TF-Technologies A/S

June 29, 2016

Lisbeth Teilmann Melchior, CEO, TF-Technologies A/S

